

Progress of the VUV setup

Casimir van der Post

 **TU**Delft

Nik|hef

Recap to where the VUV setup got around christmas

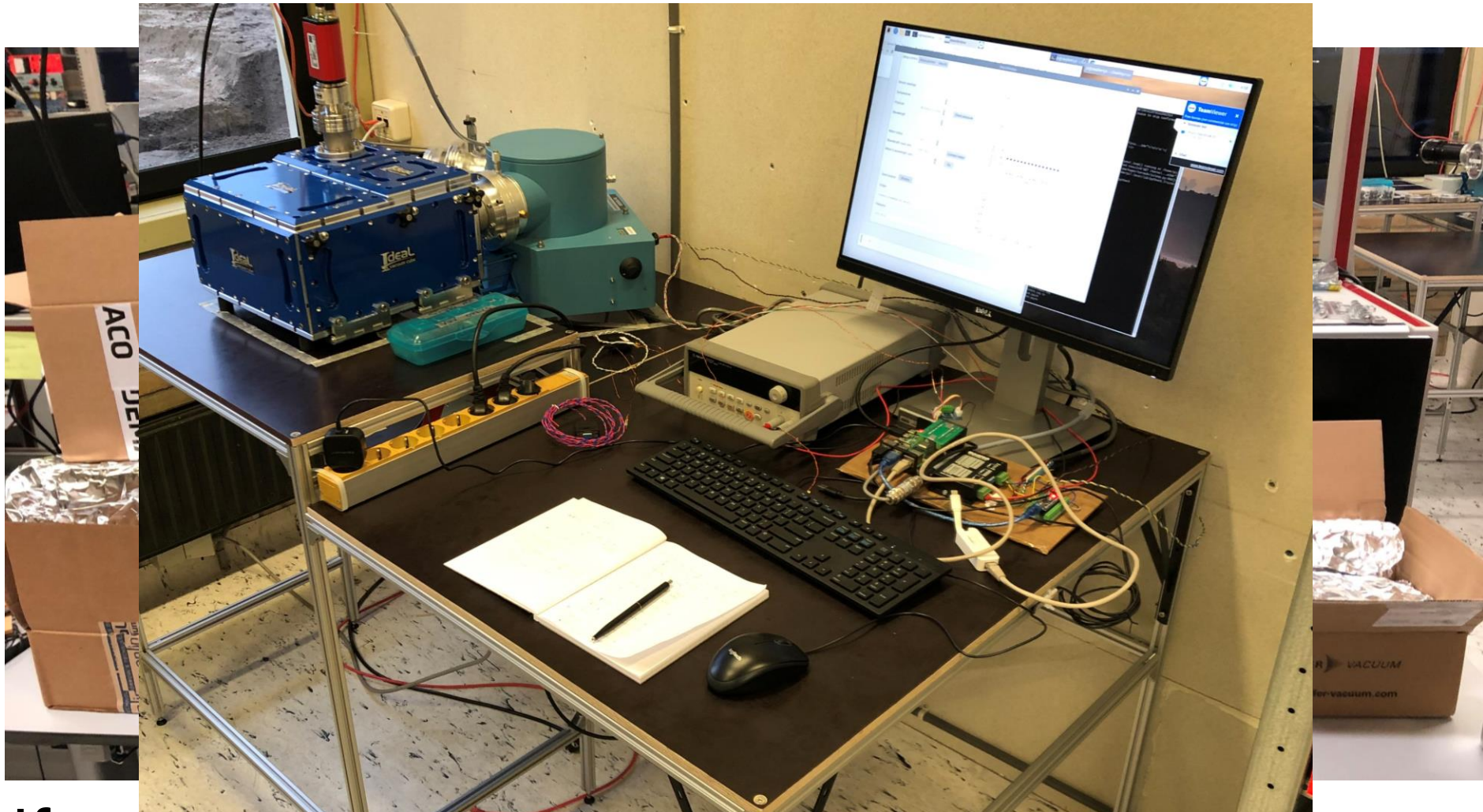

A quick explanation of the setup for the new members

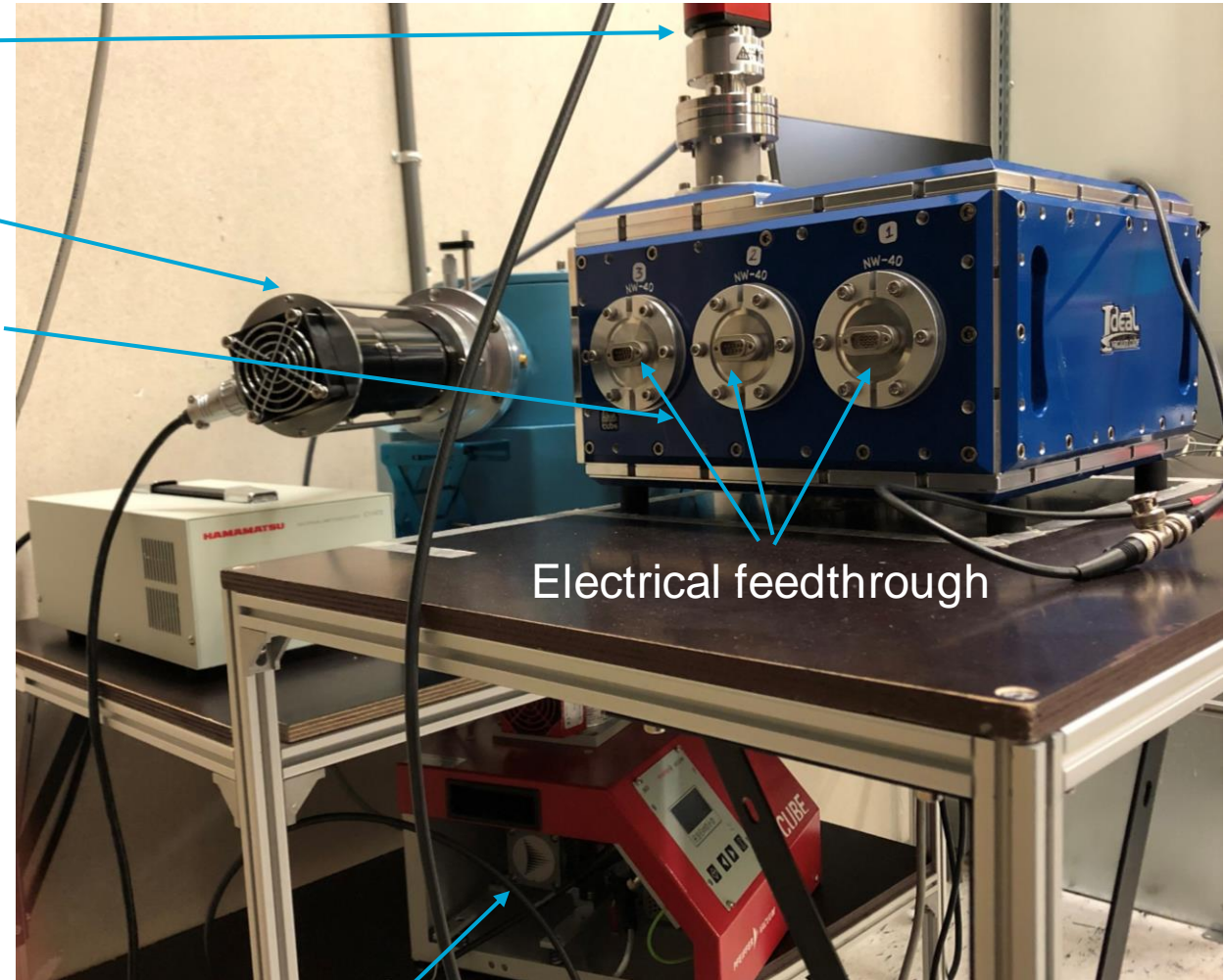
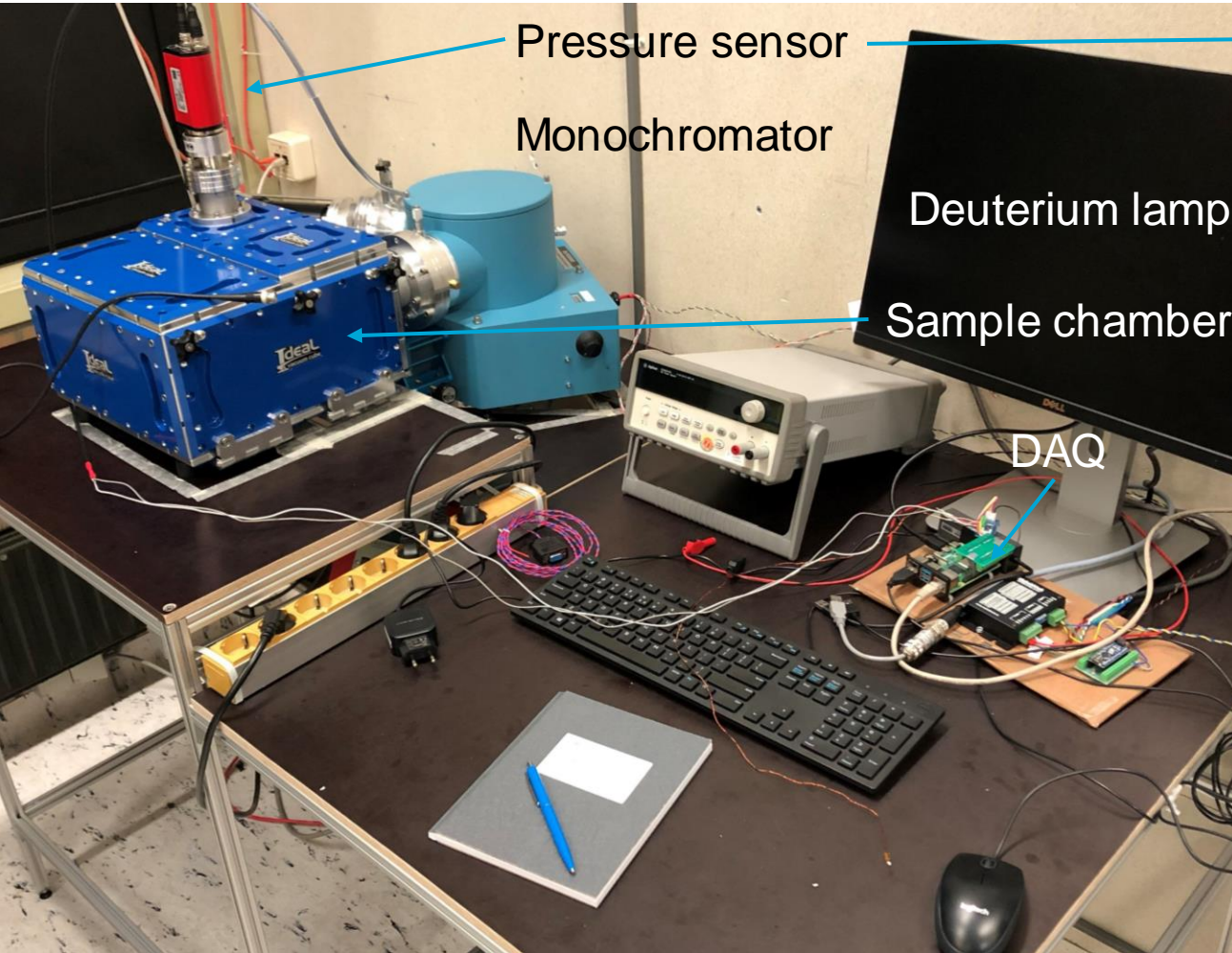

Installing and commissioning the vacuum pumping station

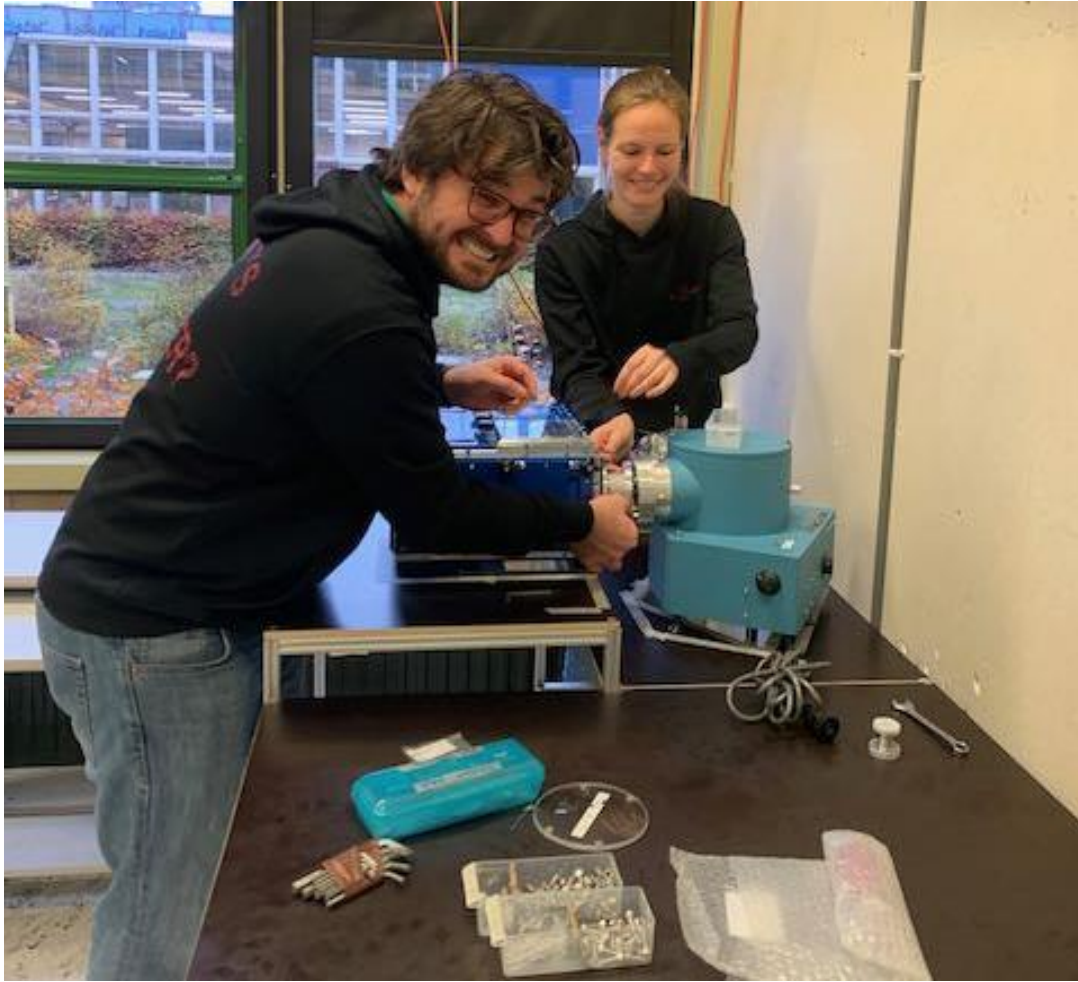

Pumping vacuum, how low can we go and who wins the bet

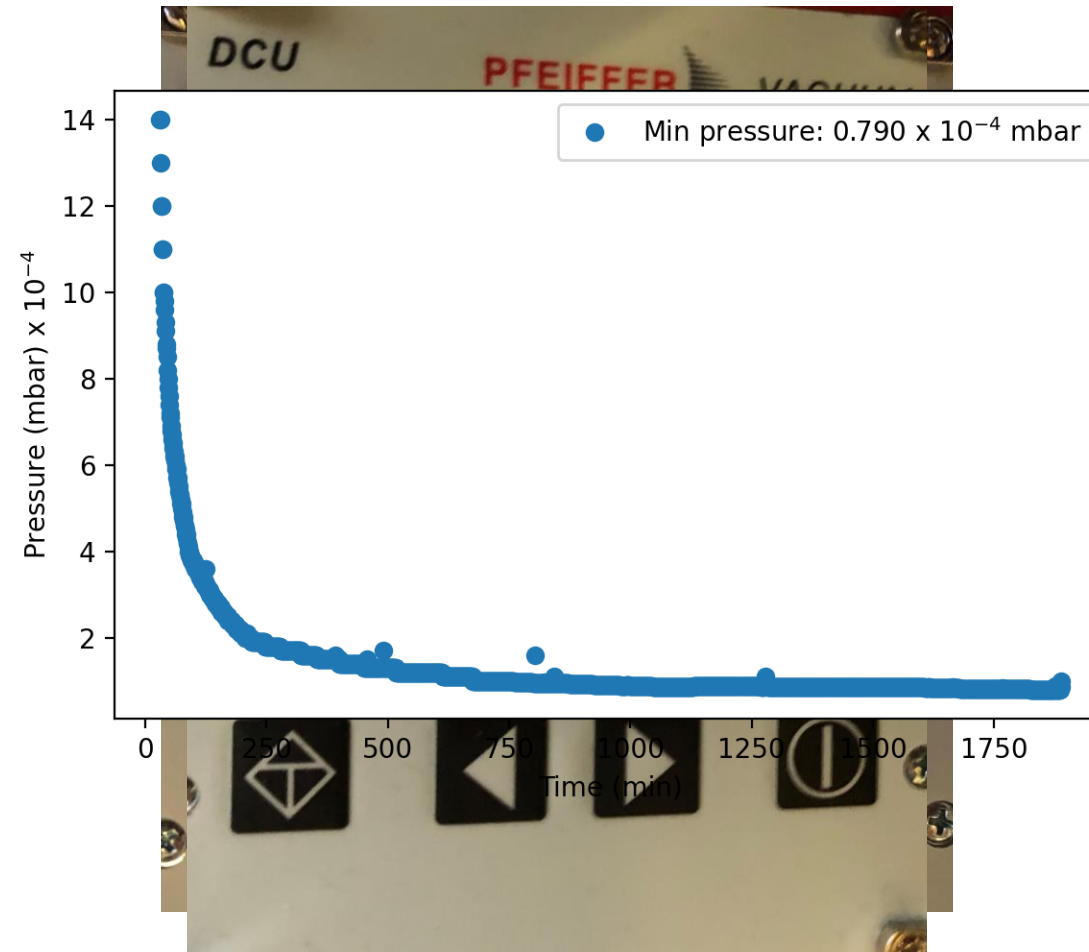

Pumping vacuum, how low can we go and who wins the bet



The sample holder is fabricated

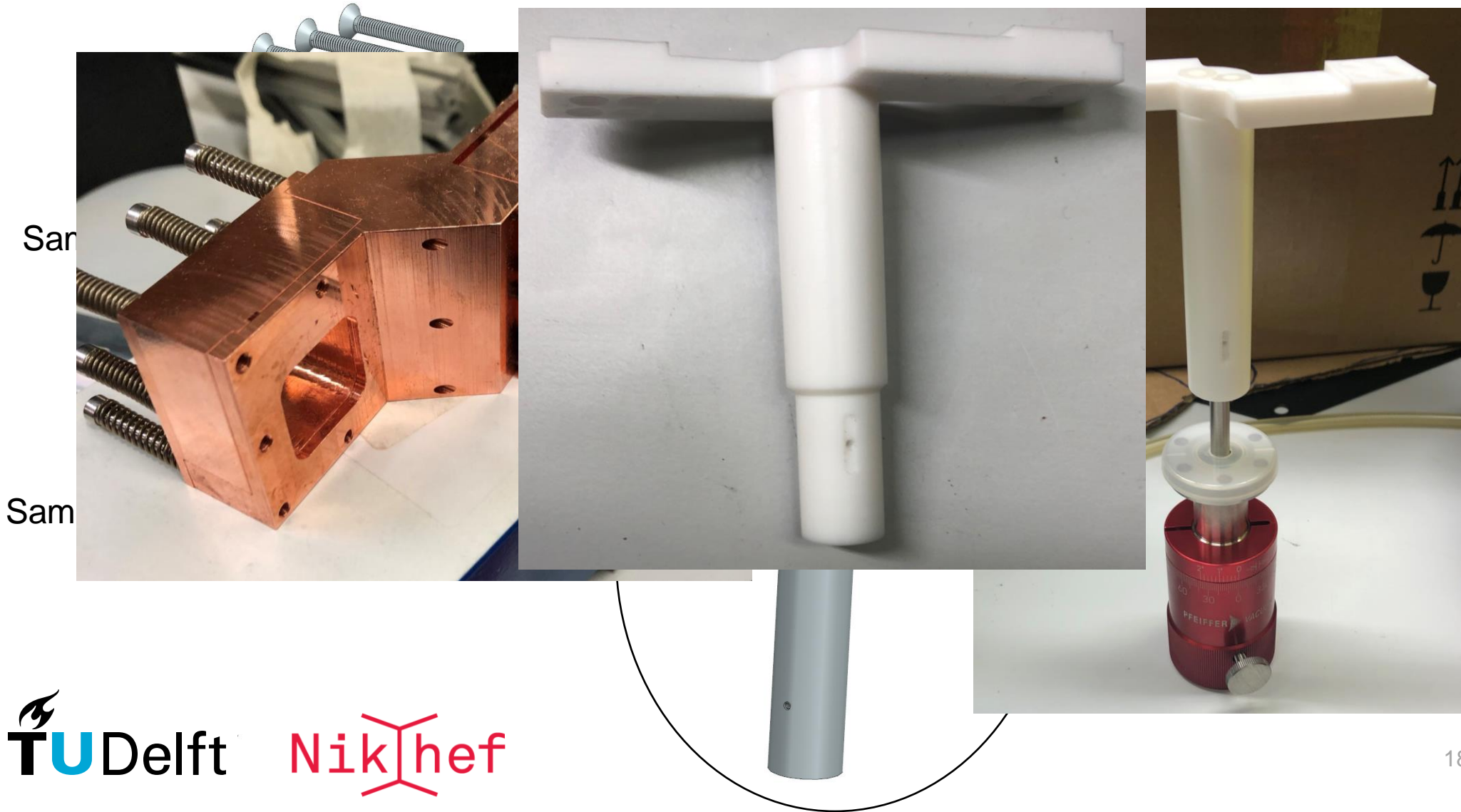

The design and fabrication of the sensor holder

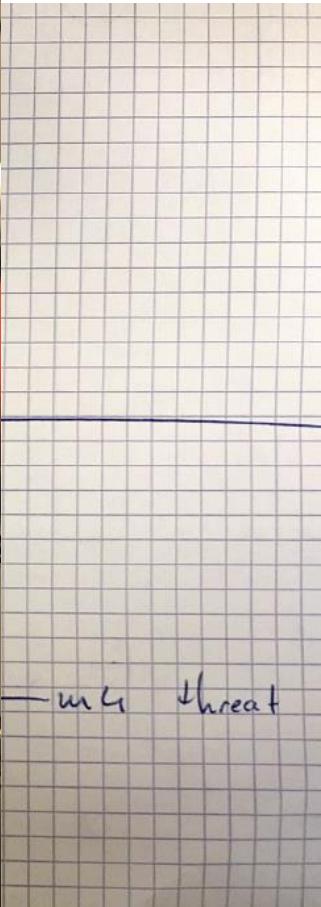
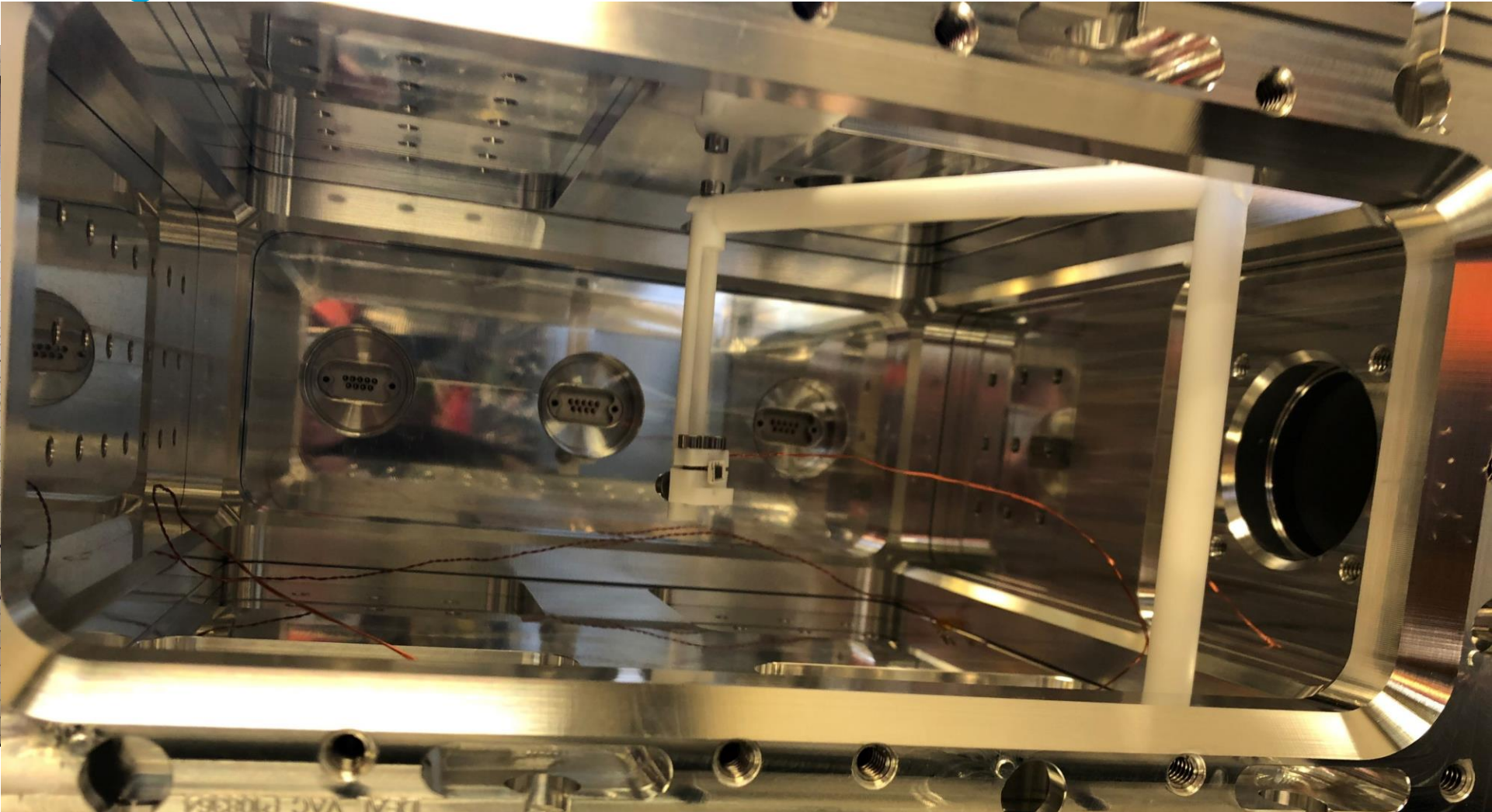
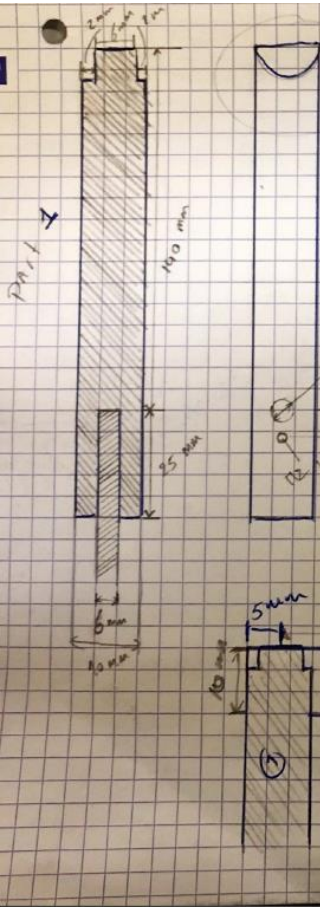

Getting the sensor cables made and organized

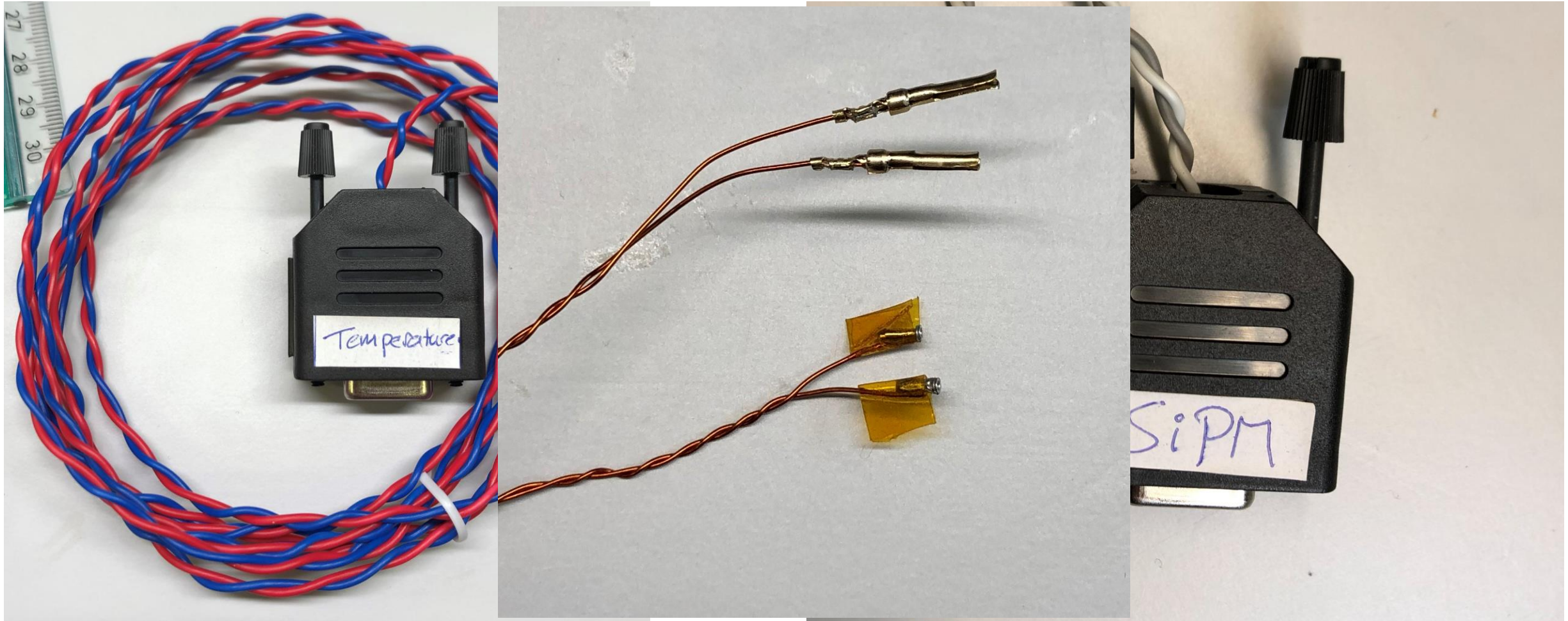

In chamber sensor testing, using a prefabricated amplifier board from a muon experiment

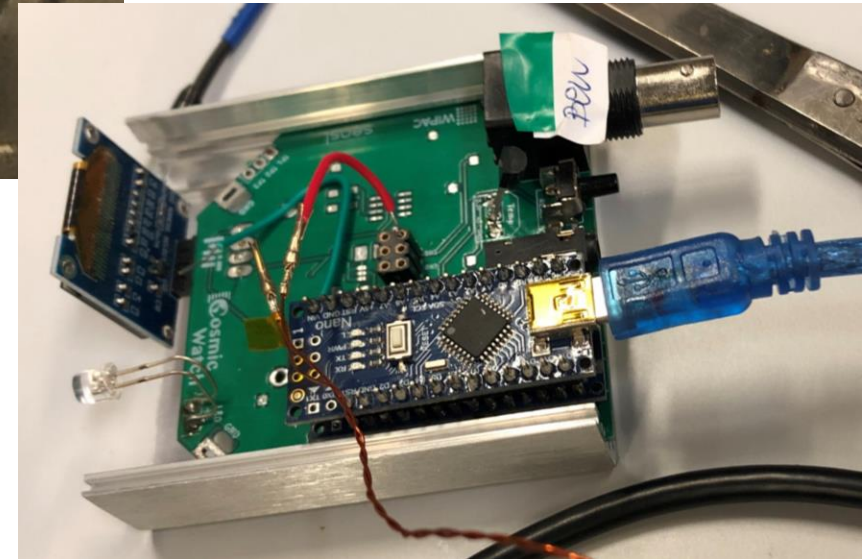
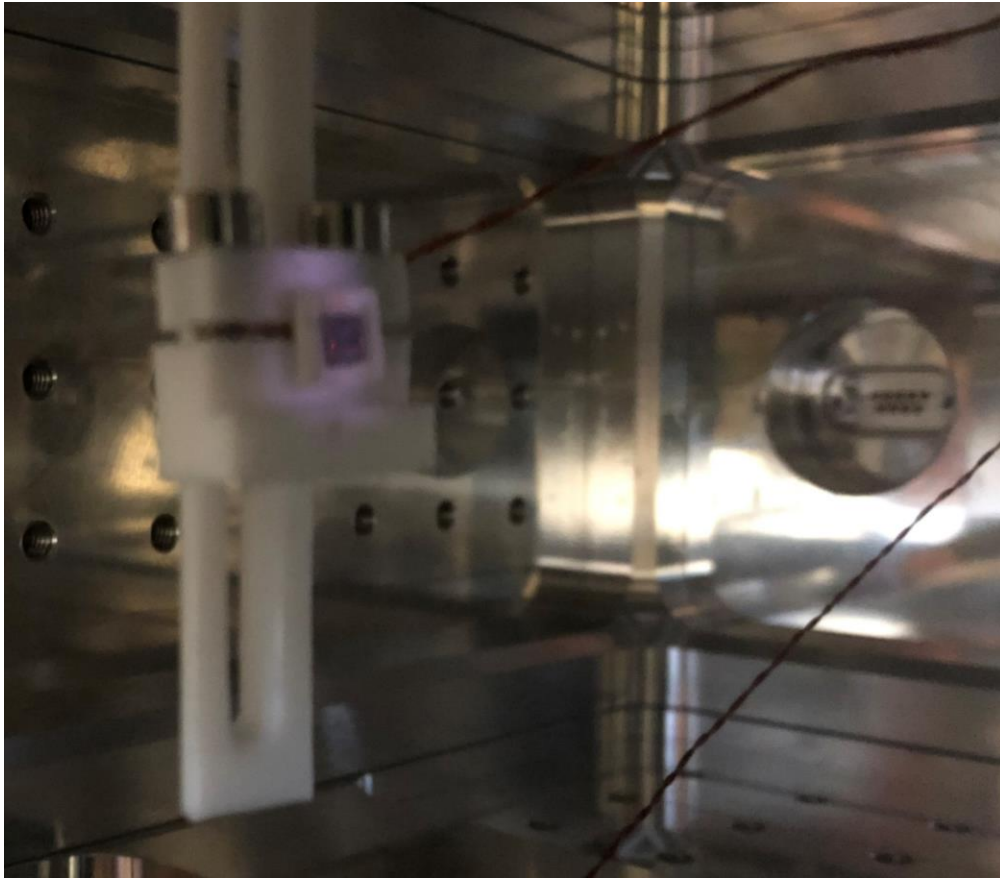

Further inspection and action!

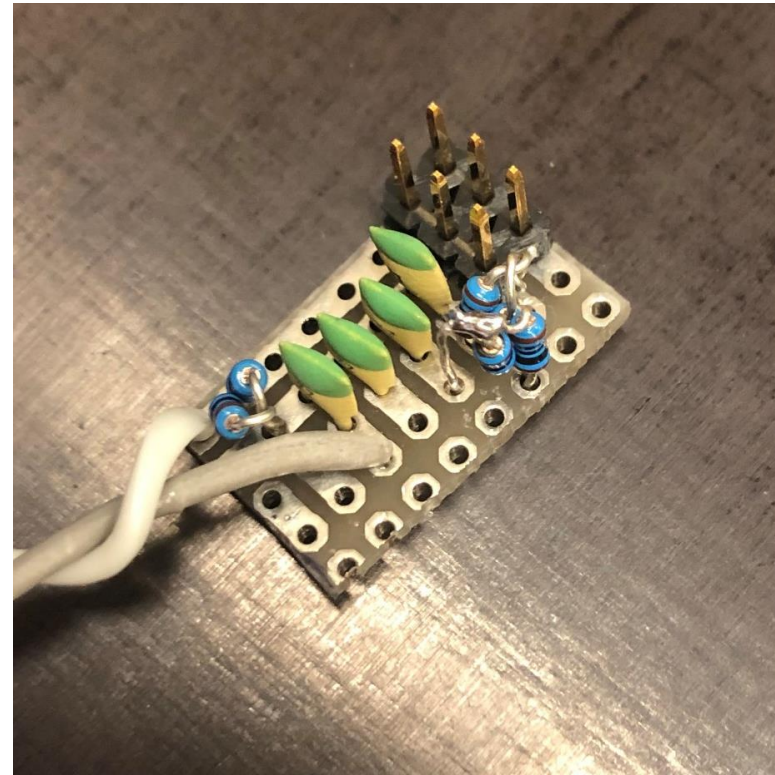
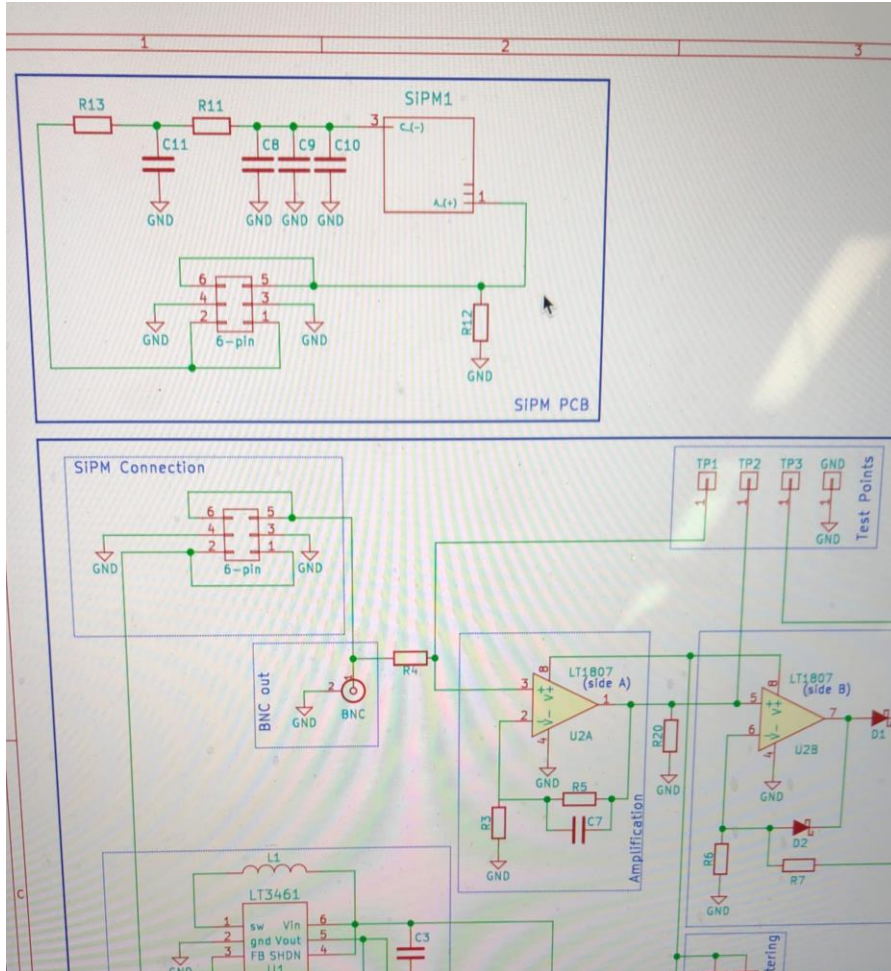

Back to controlled testing in the dark box

